

Custom Power Devices For Improve Power Quality

P Ssathish Kumar¹ M Venkatesh²

^{1,2} *Electrical & Electronics Engineering Dept, SreeDattha Institute of Engineering & Science*

ABSTRACT: This paper describes the modeling, simulation and analyzes of custom power devices for compensating voltage sag and swell conditions in three phase systems. Faults occurring in power distribution systems or facilities in plants cause the voltage sag or swell. If a fault occurs, it can damage the power system or user's facility. Sensitivity to voltage sags and swells varies within different applications. For sensitive loads (PLC's, paper mills etc.), even voltage sags of short duration can cause serious problems in the entire system. Normally, a voltage interruption triggers a protection device, which causes shutdown of the entire system. In order to mitigate power interruptions, this paper proposes a scheme for voltage sag support based on a pulse width modulated autotransformer. The proposed scheme is able to quickly recognize the voltage sag or swell condition, and it can correct the voltage by either boosting the input voltage during voltage sag events or reducing the voltage during swell events.

Keywords: DSTATCOM, Voltage sag, swell, power quality, PSCAD, PWM.

I. INTRODUCTION

The last decade has seen a marked increase on the deployment of end-user equipment that is highly sensitive to poor quality control electricity supply. Several large industrial users are reported to have experienced large financial losses as a result of even minor lapses in the quality of electricity supply [2], [3], [8]. A great many efforts have been made to remedy the situation, where solutions based on the use of the latest power electronic technology figure prominently. Indeed, custom power technology, the low-voltage counterpart of the more widely known flexible ac transmission system (FACTS) technology, aimed at high-voltage power transmission applications, has emerged as a credible solution to solve many of the problems relating to continuity of supply at the end-user level. Both the FACTS and custom power concepts are directly credited to EPRI [1], [2]. At present, a wide range of very flexible controllers, which capitalize on newly available power electronics components, are emerging for custom power applications. Among these, the distribution static compensator (D-STATCOM) very effective for reducing the voltage disturbances.

II. ANALYSIS OF D-STATCOM

The D-STATCOM is a three-phase and shunt connected power electronics based device. It is connected near the load at the distribution systems. The major components of a D STATCOM are shown in Fig.1. It consists of a dc capacitor, three-phase inverter (IGBT, thyristor) module, ac filter, coupling transformer and a control strategy. The basic electronic block of the D-STATCOM is the voltage-sourced inverter that converts an input dc voltage into a three-phase output voltage at fundamental frequency.

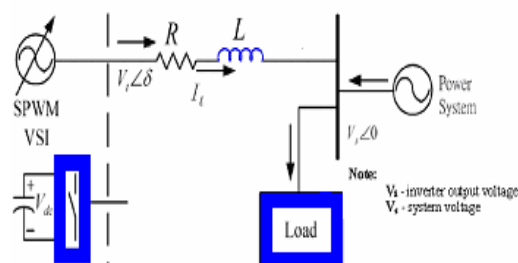

Fig.1 Basic building blocks of D-STATCOM

The D-STACOM employs an inverter to convert the DC link voltage V_{dc} on the capacitor to a voltage source of adjustable magnitude and phase. Therefore the can be treated as a voltage-controlled source. The D-STATCOM can also be seen as a current-controlled source. Fig.1 shows the inductance L and resistance R which represent the equivalent circuit elements of the step-down transformer and the inverter will be the main component of the D-STATCOM. The voltage V_i is the effective output voltage of the D-STATCOM and δ is the power angle. The reactive power output of the D-STATCOM inductive or capacitive depending can be either on the operation mode of the D-STATCOM. Referring to Fig.1, the controller of the D-STATCOM is used to

operate the inverter in such a way that the phase angle between the inverter voltage and the line voltage is dynamically adjusted so that the D-STATCOM generates or absorbs the desired VAR at the point of connection. The phase of the output voltage of the thyristor-based inverter, V_i , is controlled in the same way as the distribution system voltage, V_s . Fig.2 shows the three basic operation modes of the output current, I , which varies depending upon V_i . If V_i is equal to V_s , the reactive power is zero and the D-STATCOM does not generate or absorb reactive power. When V_i is greater than V_s , the shows an inductive reactance connected at its terminal. The current, I , flows through the transformer reactance from the D-STATCOM to the ac system, and the device generates capacitive reactive power. If V_s is greater than V_i , the D-STATCOM shows the system as a capacitive reactance. Then the current flows from the ac system to the D-STATCOM, resulting in the device absorbing inductive reactive power.

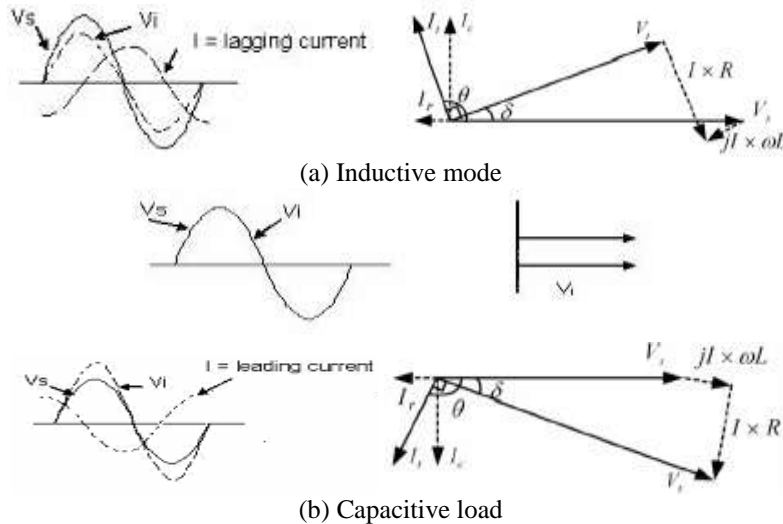

Fig.2 operating modes of the effectiveness of D-STATCOM depends on the source impedance Z_{th} and the fault level.

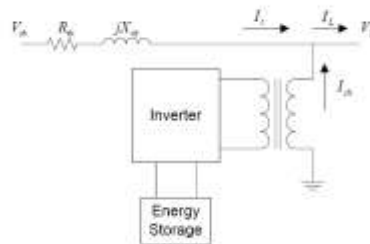

Fig3.Schematic of D-STATCOM

When the phase of the V_{sh} is in quadrature with the I_{sh} , without injecting real power the D-STATCOM can achieve the voltage sag mitigation. The shunt injecting current i_{sh} and V_L in Fig.3 can be expressed as Eq (3.1 and 3.2).

$$I_{sh} = I_L - I_S = I_L - \frac{V_{th} - V_L}{Z_{th}} \quad (3.1)$$

$$V_L = V_{th} - I_{sh} Z_{th} \quad (3.2)$$

Notice that the impedance Z_{th} is connected in parallel with the load impedance. When a short occurs near the load, the equivalent impedance Z_{th} becomes a small value. Hence, from Eq(3.1) it can be known that the D-STATCOM is then required to generate a large reactive current I_{sh} to support the load voltage V_L .

TEST CASES AND SIMULATION RESULTS

Test Case I: Voltage sag/swell mitigation using three phase 6-pulse Distribution Static compensator (D-Statcom)

Fig.4 shows the test system implemented in PSCAD/ EMTDC to carry out simulations for the D-STATCOM. The test system comprises a 230 kV transmission system, represented by a Thevenin equivalent, feeding into the primary side of a 3-winding transformer. A varying load is connected to the 11 kV, secondary

side of the transformer. A two-level D-STATCOM is connected to the 11 kV tertiary winding to provide instantaneous voltage support at the load point. A 750 μ F capacitor on the dc side provides the D-STATCOM energy storage capabilities. The set of switches shown in Fig.4 were used to assist different loading scenarios being simulated with ease. To show the effectiveness of this controller in providing continuous voltage regulation, simulations were carried out with and with no D-STATCOM connected to the system. D-STATCOM controller uses sinusoidal PWM (SPWM) technique and The aim of the control scheme is to maintain constant voltage magnitude at the point where a sensitive load is connected, under system disturbances. The control system only measures the rms voltage at the load point, i.e., no reactive power measurements are required. The VSC switching strategy is based on a sinusoidal PWM technique which offers simplicity and good response. Since custom power is a relatively low-power application, PWM methods offer a more flexible option than the fundamental frequency switching (FFS) methods favored in FACTS applications. Besides, high switching frequencies can be used to improve on the efficiency of the converter, without incurring significant switching losses. Fig.4.b shows the test system and D-STATCOM controller implemented in PSCAD/EMTDC. The D-STATCOM control system exerts voltage angle control as follows: an error signal is obtained by comparing the reference voltage with the rms voltage measured at the load point. The PI controller process the error signal and generates the required angle δ to drive the error to zero, i.e., the load rms voltage is brought back to the reference voltage. In the PWM generators, the sinusoidal signal is phase modulated by means of the angle $V_{control}$.

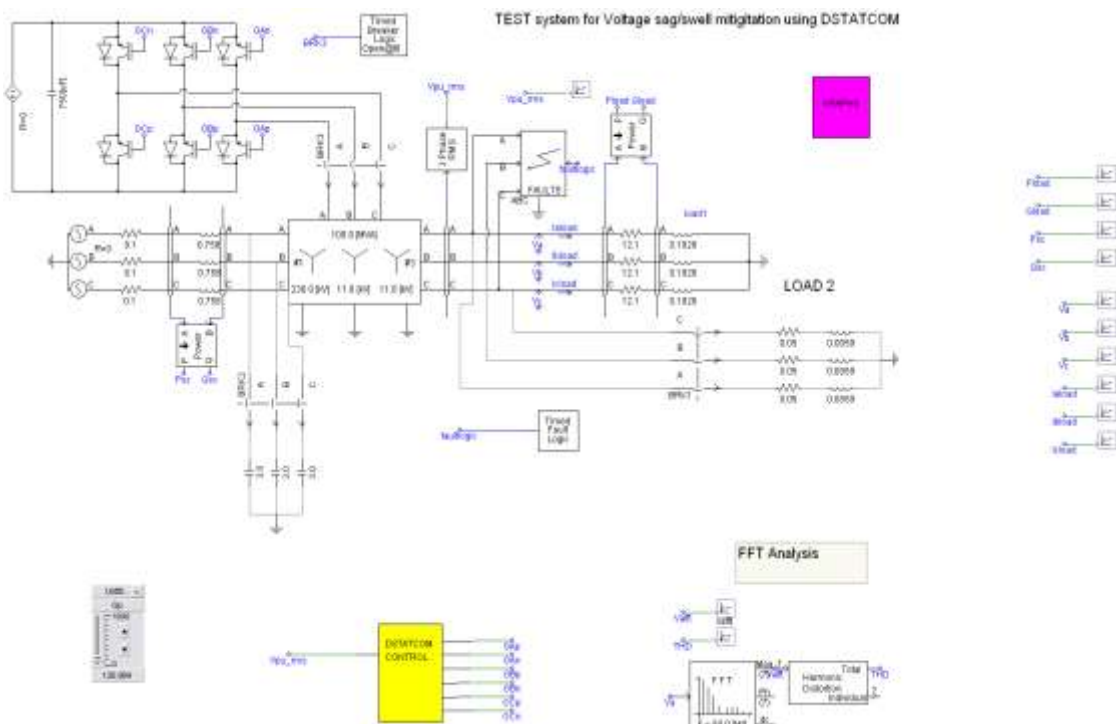

Fig.4 (a) PCSAD/EMTDC model of a three phase 6-pulse.

Fig.4 (b) Control circuit of D-STATCOM

The modulated $V_{control}$ signal is compared against a triangular signal (carrier) in order to generate the switching signals for the VSC valves. The main parameters of the sinusoidal PWM scheme are the amplitude modulation index m_a of signal $V_{control}$, and the frequency modulation index m_f of the triangular signal. The amplitude index m_a is kept fixed at 1 pu, in order to obtain the highest fundamental voltage component at the controller output. The switching frequency m_f is set at 5 KHz. It should be noted that, in this thesis, balanced network and operating conditions are assumed. The modulating angle is applied to the PWM generators in phase A. The angles for phases B and C are shifted by 240 and 120, respectively. It can be seen in Fig.4 that the control implementation is kept very simple by using only voltage measurements as the feedback variable in the control scheme. The speed of response and robustness of the control scheme are shown in the simulation results. The waveforms with and without are shown in Fig.7

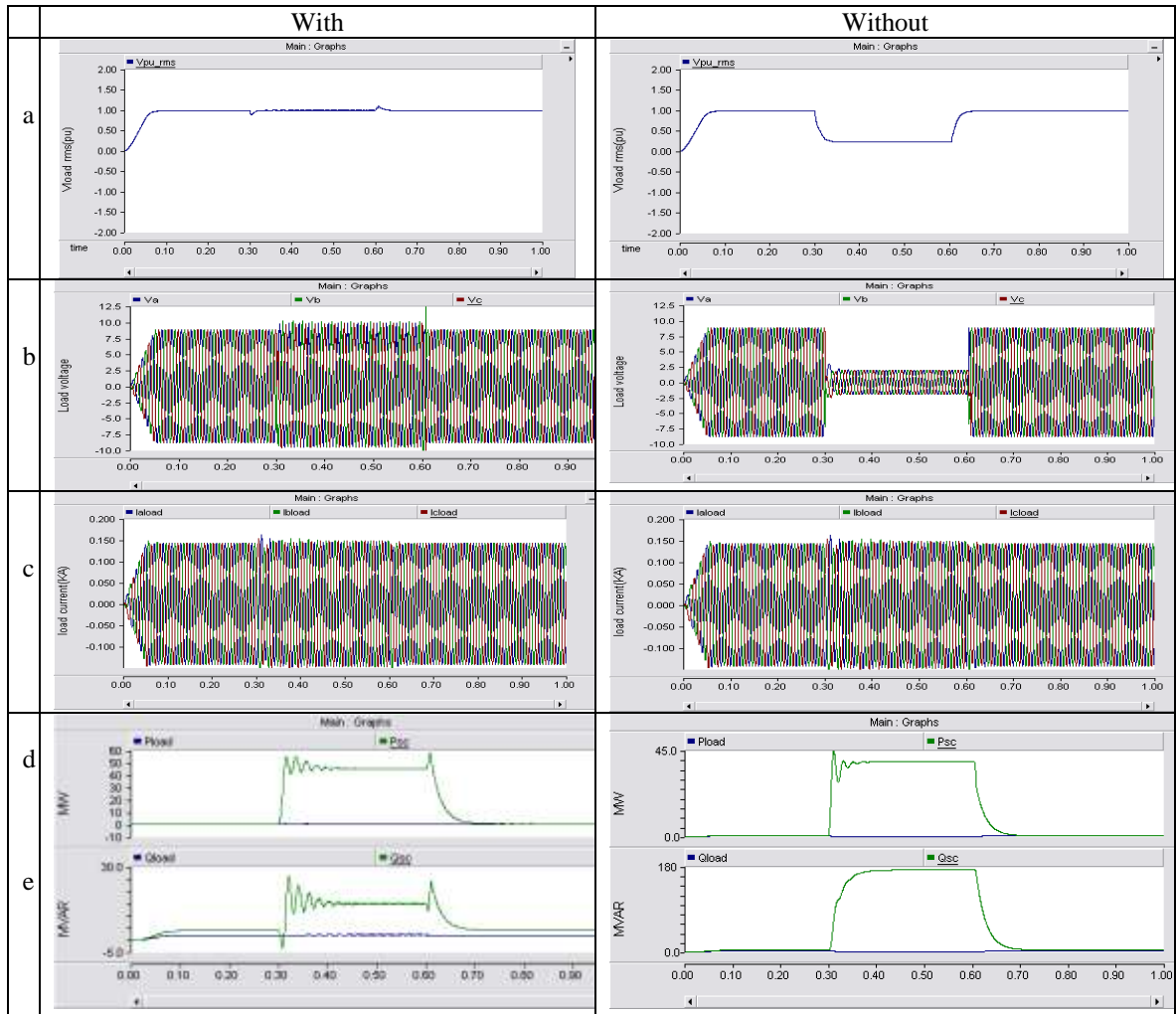

Fig.5 Waveforms for a voltage of 81% (a) rms load voltage (pu) (b) Instantaneous load voltages (kV) (c) Instantaneous load currents (kA) (d) Load and source active powers (MW) (e) Load and source reactive power (MVAR)

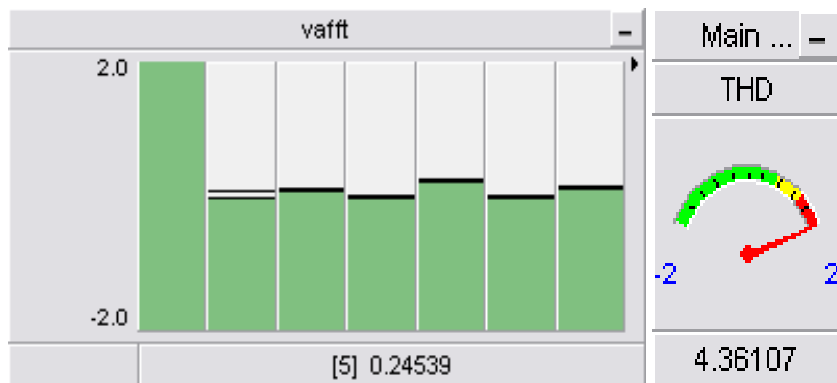

Fig.6.Harmonic analysis at load during fault

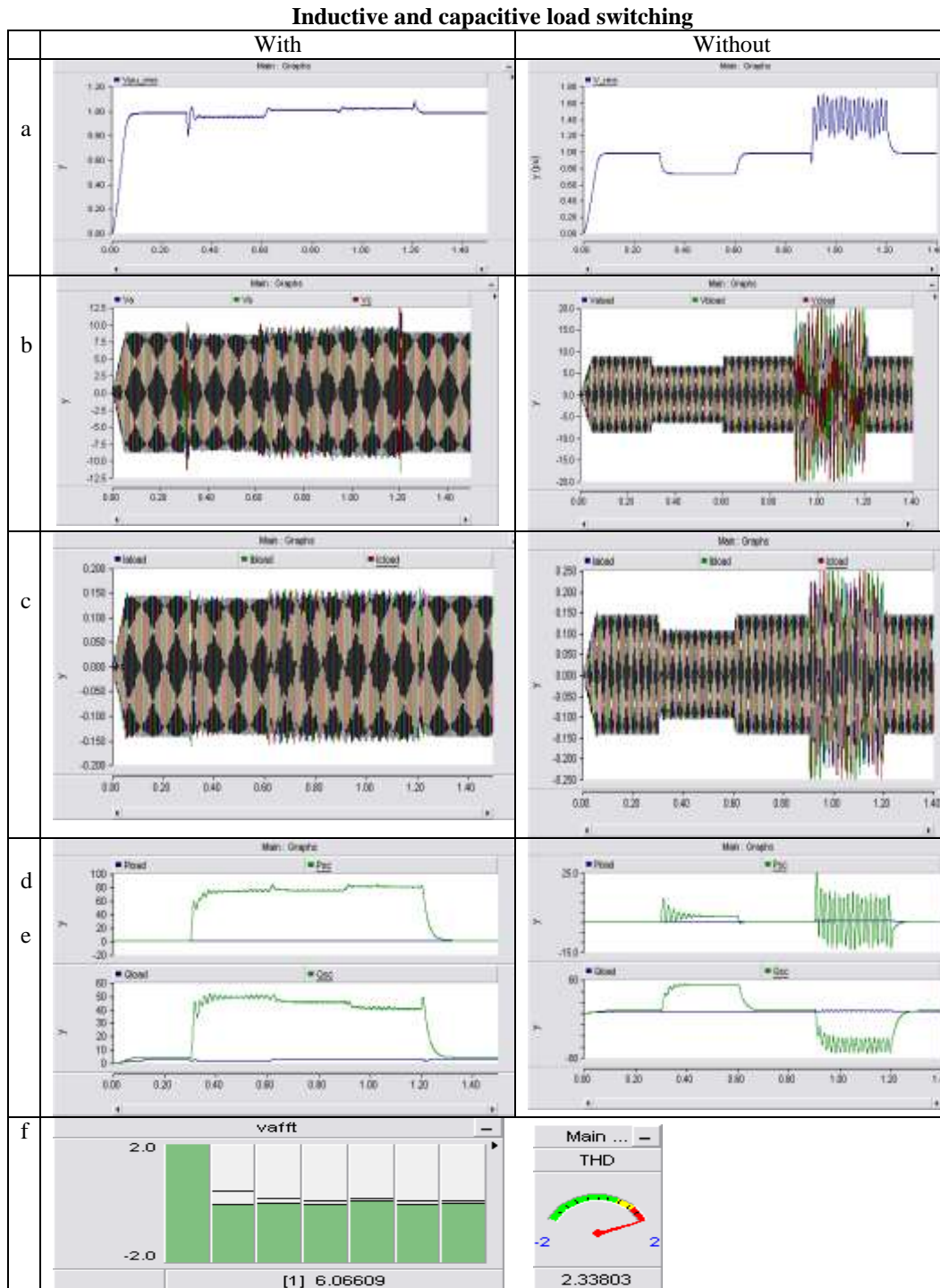

Fig.7 waveforms due to load switching (a) rms load voltage (pu) (b) Instantaneous load voltages(KV) (c) Instantaneous load currents(KA) (d) load and source active powers(MW) (e) load and source reactive power(MVAR) (f) harmonic analysis at load during fault(%)

The test case results shown in Fig.7 show that the maintains the load voltage and load current to its rated value during sudden switching on inductive load and capacitive load at different intervals. Harmonics generated by during the period of disturbance is eliminated by high pass filter connected at load, which is designed at switching frequency of PWM pulses i.e of 5 kHz.

III. CONCLUSION

In this chapter Modelling, simulation & analysis is presented and injects currents in shunt to mitigate sags/swells. A 6-pulse is implemented for balanced faults and sudden load switching. The can mitigate up to 80% sag /swell with Dc side voltage (V_{DC}) =50KV. Simulation results show that for the same sag compensation DVR requires less energy (V_{DC}) than and hence DVR costs less than observes a large voltage over shoot at the time of fault clearance. Voltage sag is mainly characterized by magnitude and duration. Magnitude of the voltage sag can be calculated by RMS value, Fundamental component of the voltage or peak value of the voltage. Point-on-wave characteristics such as point on wave of sag initiation and point-on-wave of voltage recovery can be used to calculate the duration of sag. During the voltage sag, there is not only change in the magnitude of the voltage but also change in the phase angle of the voltage, which are known as phase angle jumps. Magnitude of voltage sags due to three phase faults can be calculated by voltage divider model. Main causes of voltage sags are faults in the power systems and most severe fault is three phase fault and their effects on sensitive loads (PLC's, computers, paper mills etc..) are discussed . Test cases for effects of induction motor at sensitive loads due to faults in the power system and starting of induction motor are simulated in PSCAD/Emtdc and their results are analyzed. So mitigation of voltage sags/swells at the sensitive loads with in a short time is very much essential in the view of financial loses occur due to their interruption.

REFERENCES

- [1]. N. Hingorani, "FACTS—Flexible ac transmission systems," in *Proc. IEE 5th Int. Conf. AC DC Transmission*, London, U.K., 1991, Conf. Pub. 345, pp. 1–7.
- [2]. , "Introducing custom power," *IEEE Spectrum*, vol. 32, pp. 41–48, June 1995.
- [3]. S. Nilsson, "Special application considerations for Custom Power systems," in *Proc. IEEE Power Eng. Soc., Winter Meeting 1999*, vol. 2, 1999, pp. 1127–1130.
- [4]. Manitoba HVDC Research Centre, "PSCAD/EMTDC: Electromagnetic transients program including dc systems," 1994.
- [5]. A. M. Gole, O. B. Nayak, T. S. Sidhu, and M. S. Sachdev, "A graphical electromagnetic simulation laboratory for power systems engineering programs," *IEEE Trans. Power Syst.*, vol. 11, pp. 599–606, May 1996.
- [6]. L. Gyugyi, "Dynamic compensation of ac transmission lines by solid state synchronous voltage sources," *IEEE Trans. Power Delivery*, vol. 9, pp. 904–911, Apr. 1994.
- [7]. A. Hernandez, K. E. Chong, G. Gallegos, and E. Acha, "The implementation of a solid state voltage source in PSCAD/EMTDC," *IEEE Power Eng. Rev.*, pp. 61–62, Dec. 1998.
- [8]. G. Venkataramanan and B. Johnson, "A pulse width modulated power line conditioner for sensitive load centers," *IEEE Trans. Power Delivery*, vol. 12, pp. 844–849, Apr. 1997.
- [9]. I. T. Fernando, W. T. Kwasnicki, and A. M. Gole. Modeling of conventional and advanced static var compensators in electromagnetic transients simulation program.
- [10]. L. Xu, O. Anaya-Lara, V. G. Agelidis, and E. Acha, "Development of prototype custom power devices for power quality enhancement," in *Proc. 9th ICHQP 2000*, Orlando, FL, Oct. 2000, pp. 775–783.